



User Manual

PCE-PTR 200N Force Gauge



User manuals in various languages (français, italiano, español, português, nederlands, türk, polski, русский, 中文) can be found by using our product search on: www.pce-instruments.com

Last change: 22 October 2019
v1.0



Contents

1	Safety notes	1
2	Specifications	2
3	Important information before use	2
4	Introduction	3
5	Characteristics	3
6	Delivery contents	3
7	Device description	4
7.1	Keys and adaptor	4
7.2	Dimensions	5
7.3	Circuit diagram of 3.5 mm jack	5
7.4	Display	6
7.5	Keys.....	7
8	Operation	8
9	Options	10
10	Alarm	11
11	Calibration by using weights	11
12	Rechargeable battery	11
13	Measurement	11
13.1	Choosing the sample.....	11
13.2	Preparation of the sample	12
13.3	Important information about the measurement	12
14	Warranty	14
15	Disposal	14

1 Safety notes

Please read this manual carefully and completely before you use the device for the first time. The device may only be used by qualified personnel and repaired by PCE Instruments personnel. Damage or injuries caused by non-observance of the manual are excluded from our liability and not covered by our warranty.

- The device must only be used as described in this instruction manual. If used otherwise, this can cause dangerous situations for the user and damage to the meter.
- The instrument may only be used if the environmental conditions (temperature, relative humidity, ...) are within the ranges stated in the technical specifications. Do not expose the device to extreme temperatures, direct sunlight, extreme humidity or moisture.
- Do not expose the device to shocks or strong vibrations.
- The case should only be opened by qualified PCE Instruments personnel.
- Never use the instrument when your hands are wet.
- You must not make any technical changes to the device.
- The appliance should only be cleaned with a damp cloth. Use only pH-neutral cleaner, no abrasives or solvents.
- The device must only be used with accessories from PCE Instruments or equivalent.
- Before each use, inspect the case for visible damage. If any damage is visible, do not use the device.
- Do not use the instrument in explosive atmospheres.
- The measurement range as stated in the specifications must not be exceeded under any circumstances.
- Non-observance of the safety notes can cause damage to the device and injuries to the user.

We do not assume liability for printing errors or any other mistakes in this manual.

We expressly point to our general guarantee terms which can be found in our general terms of business.

If you have any questions please contact PCE Instruments. The contact details can be found at the end of this manual.

2 Specifications

Measuring range	0 ... 200 N
Calibration	0.1 N
Pressure calibration	1 Mpa
Load cell	integrated load cell with M6 connection
Measuring range	1 ... 100 % f. s.
Measurement accuracy	±0.5 %
Units	n, kg, lb
Display	LCD
Operating temperature	+10 ... +30 °C
Relative humidity	15 ... 80 %
Working conditions	The device must not be located near sources of vibration or corrosive substances
Weight	1 kg / 2.2 lb

3 Important information before use

- Wear protective mask and gloves.
- Do not use damaged or bent fixtures.
- If “Err-1” appears on the LCD, it indicates that the test load the sensor measures is 110 % larger than the rated load. Decrease the load immediately. Make sure the load applied is smaller than 105 % the rated load after the meter is restarted.
- Make sure the force gauge is not overloaded. Overload may damage the sensor.
- Do not use sharp tools to press buttons.
- Keep the meter away from liquids and store it in a cool, dry place and away from sources of vibration.
- Only use the charger delivered with the force gauge for charging.
- Connect the meter to the computer in line with the instructions to avoid problems.
- Only connect the charger to an intact socket as damaged sockets can cause fire.
- Make sure the charger is securely inserted into a socket if the product needs to be charged. Looseness may cause short circuit, resulting in electric shock or fire.
- Remove the charger after charging to avoid accidents.
- Do not touch the power adaptor with wet hands.
- Do not bend or twist the test head. A measurement may only be made perpendicularly to the meter.

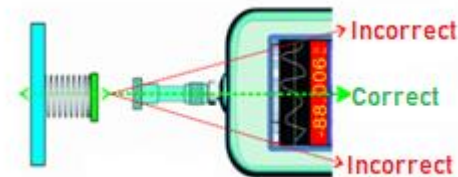

4 Introduction

The penetrometer PCE-PTR 200N is a practical handheld meter to check the degree of ripeness of different types of fruit. This penetrometer is more accurate than most other models. The penetrometer will provide some valuable information about the ideal harvest time. The meter will also help monitoring the quality during storage, transport and sales. The penetrometer is equipped with an internal load cell controlled by a microprocessor. This microprocessor makes a quick and accurate readout possible. The meter has a mounting fixture for a test stand. This reduces possible user error to a minimum and makes series of measurements possible.

5 Characteristics

Display	LCD / 180 ° rotatable / backlit
Interface	USB
Alarm	Fracture alarm, upper / lower offset, limit alarm
Open Collector Transistor	12 V / 50 mA
Memory	10 measurements
Peak value measurement	yes

6 Delivery contents

- 1 x Penetrometer PCE-PTR 200N
- 1 x Penetration tip Ø 6 mm
- 1 x Penetration tip Ø 8 mm
- 1 x Penetration tip Ø 11 mm
- 1 x Flathead adapter
- 1 x Hook adapter
- 1 x Ball head adapter
- 1 x Chisel head adapter
- 1 x Notch head adapter
- 1 x Extension rod (65 mm / 2.55")
- 1 x USB cable
- 1 x Power plug
- 2 x Locking ring
- 1 x Equipment case
- 1 x Operation manual

The evaluation software can be downloaded here: https://www.pce-instruments.com/deutsch/download-win_4.htm.

7 Device description

7.1 Keys and adaptor



- 1. Measuring adaptor
- 2. Clamping nut
- 3. LCD

- 4. LED
- 5. Control panel



- 1. Switched output
- 2. USB interface
- 3. Power connection

7.2 Dimensions

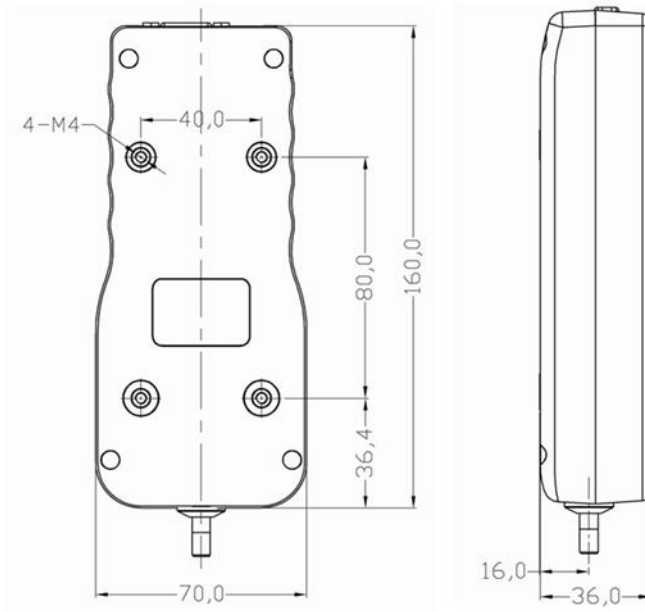

All dimensions in mm

7.3 Circuit diagram of 3.5 mm jack



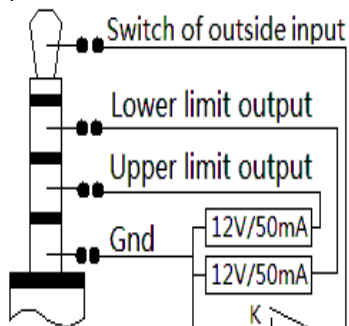

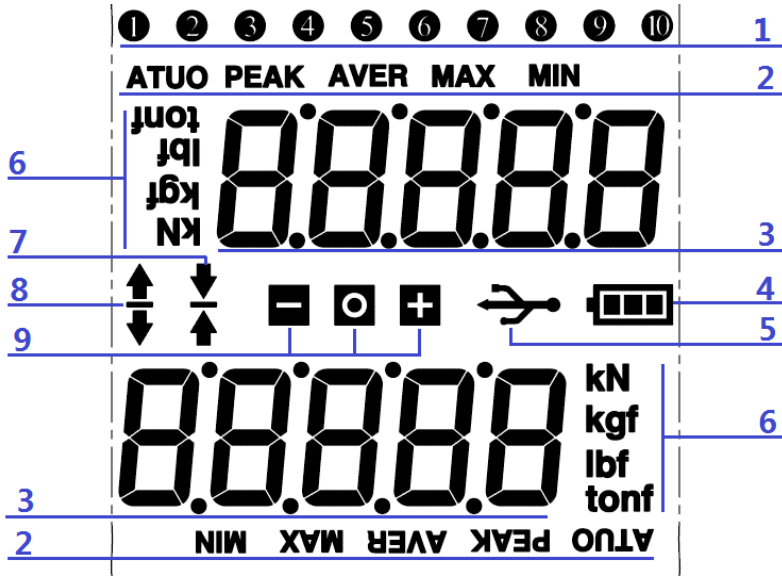



Here you can find the circuit diagram for connecting a 3.5 mm jack in order to establish a connection to the switched outputs.



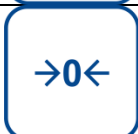

1. Number of values saved (*these do not turn when the display does*)
2. ATUO: Automatic peak clearing
 PEAK: Manual peak clearing
 AVER: Average of saved peak values
 MAX: highest value measured
 MIN: lowest measured value
3. Displays current the peak value or current measurement value in real time, depending on display orientation
4. Battery level indication
5. PC connection
6. Measuring unit
7. Push (compression) icon
8. Pull (tension) icon
9. "—" the displayed value is smaller than the set limit
 "o" Measurement successful or interrupted
 "+" the displayed value exceeds the set limit

7.5 Keys

Key	Test mode	Online test mode (USB connected)	Storage mode	Menu
	On / off	On / off	x	x
	Unit	x	Exit mode	Leave option
	Zeroing	Zeroing	Memory is cleared	x
	Reading and unit are sent	x	Data are sent	Up
	Saved readings are queried	x	Switch between AVER, MAX and MIN	Down
	Menu is opened	Invalid	Back to measurement mode	Selected option is opened
	Displayed value is saved	Displayed value is saved	Left	x
	Peak value is deleted	Peak value is deleted	Right	x

8 Operation





Power on and off:

- Press  to power on/off.



Open menu and select an option:

- In test mode, press  to open the settings menu and to select individual options.



Zero and delete a saved value:

- In test mode, press  to reset the measured value to zero.
- In storage mode, press  to delete individual memory items. These individual memory items flash and can be selected by means of the arrow keys  and  and deleted individually.





Change unit and leave a mode:

- In test mode, press  to change the unit.
- In the menu, you can use  to leave a selected option or menu.
- In storage mode, you can use  to leave this mode and return to test mode.



Navigate through the options:

- In the menu, you can use the arrow keys  and  to navigate through the options.

Save:

- In test mode, you can reset the peak value by using the  key.
- Also in test mode, you can save the peak value by using the  key.
- In storage mode, you can navigate to the right through the memory items by using the  key.
- Also in storage mode, you can navigate to the left through the memory items by using the  key.

Querying saved values, AVER, MAX, MIN:

- In test mode, you can open storage mode with the  key.
- In storage mode, you can press  to switch between AVER, MAX and MIN.

USB interface:

- Please observe the instructions in the separate software manual.

9 Options

Option	Name	Options	Meaning	Default setting
F-0	code	code	Analogue code	x
F-1	ast	close/1d/2d/3d	Auto zero from 1/2/3 digits	1 d
F-2	speed	6~200Hz	Measuring frequency	50 Hz
F-3	cal	Two- or three-point	Calibration	x
F-4	old_g	9. 7000~9. 9000	Gravity value at calibration location	9. 7833
F-5	new_g	9. 7000~9. 9000	Gravity value at user location	9. 7833
F6	j-out	inter/outer/cut/ off	Alarm settings Inter (within the alarm limit) Outer (outside the alarm limit) Cut (material fracture alarm) Off (alarm deactivated)	outer: outside alarm limit
F-7	lo		Lower alarm limit	0
F-8	hi		Upper alarm limit	Maximum
F-9	cut	10~90 %	Overload alarm	50 %
F-10	peak	key/3~60 sec	Display time of peak value	Remove by pressing key
F-11	bps	4800~57600	Bandwidth	38400 bps
F-12	print	key/stabl/chang/conti	Key: data transfer when key is pressed Stabl: data transfer when value is stable Chang: data transfer when value changes Conti: permanent data transfer	Key: data transfer when key is pressed
F-13	angle	0 °/180 °	Display orientation	0 °
F-14	off_t	no/3~60 min	Auto Power Off	Off: Auto power Off deactivated
F-15	Led	on/off/auto	Backlight On (always on) Off (always off) Auto: automatic (5 seconds)	Auto: automatic
F-16	reset	no/yes	Factory settings	No

10 Alarm

- **Inter:** This option triggers an audible signal when the measured value is between the lower and the upper alarm limit. „+“ and „-“ will flash in the display.
- **Outer:** This option triggers an audible signal when:
 - A: the measured value is below the lower limit („-“ will flash in the display)
 - B: the measured value is above the upper limit („+“ will flash in the display)
- **Off:** This option deactivates the alarm.

11 Calibration by using weights

You can select either „cal=2“ (2-point calibration) or „cal=3“ (3-point calibration).

Go to the menu F-3 and either select „cal=2“ or „cal=3“ by means of the arrow keys. Confirm your selection with OK. Remove all attachments from the device that affect the measuring cell. Confirm the zero calibration by pressing the OK key. To calibrate the second point, you can use the pre-set weight or select the desired weight by using the arrow keys. Confirm with the OK key. Attach the chosen weight to the device and confirm with OK. The indication in the display will start flashing. When the calibration is finished, the display will “CAL”.

The procedure for the 3-point calibration is the same as for the 2-point calibration, just with one more calibration point.

12 Rechargeable battery

This product is configured with a 1600 mAh 6 V Ni-Hi rechargeable battery. If it is fully charged, the product can be running uninterruptedly for 10 hours. When shut down, the battery will discharge in 3 months. Make sure the battery level is always sufficient. In case of power shortage, use the delivered DC 12 V/1000 mA power adaptor to charge the product. It will be fully charged within 8 ~ 10 hours. Remove the power adapter immediately after the product prompts full charge. Otherwise, longtime charging may cause the battery to overheat. Only charge the battery when it is completely flat. Frequent charging shortens the battery life.

13 Measurement

13.1 Choosing the sample

Following this procedure before making a measurement is very important to ensure valid readings which are helpful when it comes to determining the best harvest time. Make sure the samples represent a typical part of the total harvest (minimum number of samples, sizes, quality, etc.). It is recommended to create your own sampling protocol. The samples should come from various areas of the harvest. It is important that the selected fruit has equal average sizes as the firmness also depends on the size (the firmness increases with the size). It is also crucial that the chosen samples are completely flawless and undamaged. The measuring interval should be about every 3 ... 5 days and approx. 10 pieces of fruit should be measured.

13.2 Preparation of the sample

2 measurements of the centre of each piece of fruit (one per side) should be made. The mean value will then be calculated from both measurements.

Choose the measuring spots and remove the skin at the selected spots. The peeled area should be a bit larger than the diameter of the penetration tip. The penetration tip to be selected mainly depends on the type of fruit and the degree of ripeness. The smaller tips are normally used for relatively firm or small samples. The larger tips, on the other hand, are used for softer and larger samples. It is very important to get reproducible and comparable readings. However, it is also important that the samples have the same temperature. The temperature is decisive for the firmness of fruit, i. e. the higher the temperature, the softer the fruit will be.

13.3 Important information about the measurement

After preparing the sample and selecting the right tip, you can measure the firmness at both measuring spots. To get a correct firmness value, the following must be observed:

During the measurement, firmly hold the sample on a flat and hard surface such as a table or a plate to make sure the force can be exerted correctly.

Make sure that the head of the meter, the penetration tip and the sample point at the same direction during the complete measurement. Avoid movement or turning of the measuring tip during the measurement. Always apply pressure perpendicularly. Different measuring angles are not allowed.

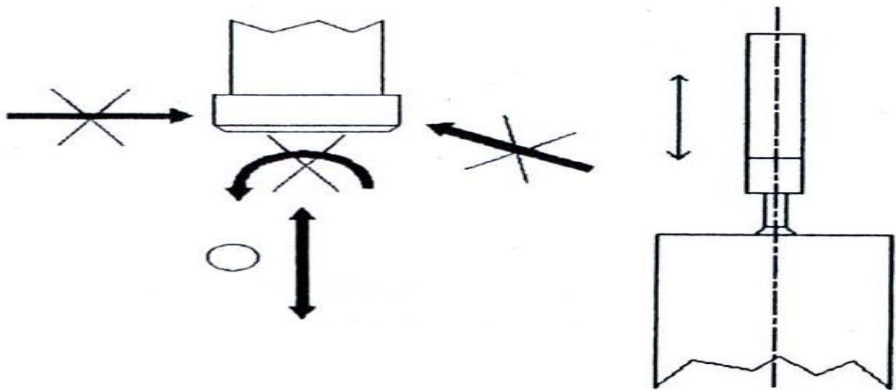

Apply **SLOW AND EQUAL** pressure with the penetration tip up to the recess that is marked on the tip. Irregular pressure can falsify the measurement. The complete procedure should take approx. 2 seconds.

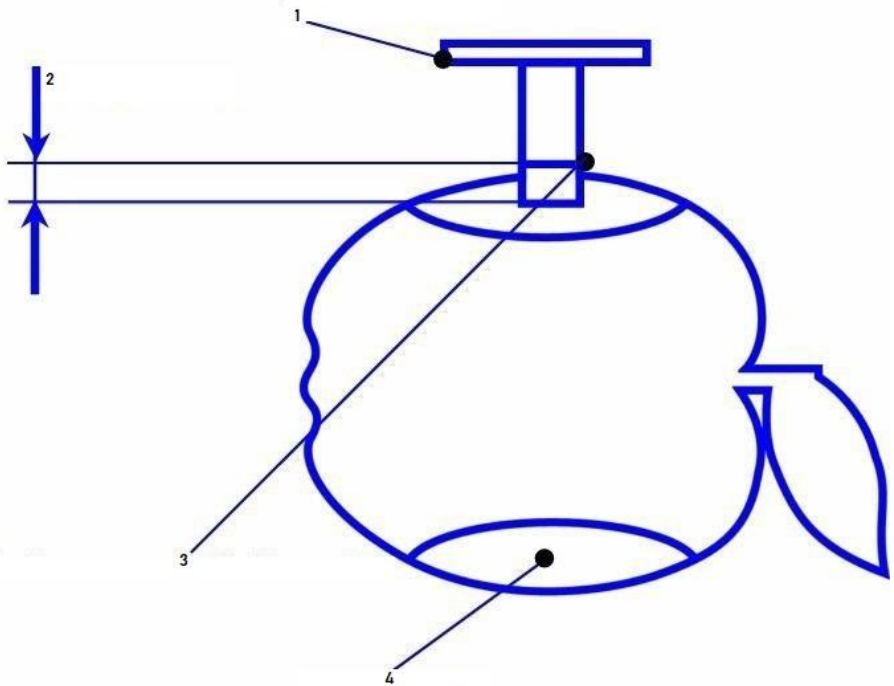

- 1 Locking ring
- 2 $t = 2$ seconds
- 3 Mark on penetration tip
- 4 Peeled zone

Try to make all measurements under equal conditions to ensure reproducible values for comparative and statistical purposes.

To achieve high accuracy, use a test stand which enables you to apply regular pressure at a constant penetration angle.



14 Warranty

You can read our warranty terms in our General Business Terms which you can find here: <https://www.pce-instruments.com/english/terms>.

15 Disposal

For the disposal of batteries in the EU, the 2006/66/EC directive of the European Parliament applies. Due to the contained pollutants, batteries must not be disposed of as household waste. They must be given to collection points designed for that purpose.

In order to comply with the EU directive 2012/19/EU we take our devices back. We either re-use them or give them to a recycling company which disposes of the devices in line with law.

For countries outside the EU, batteries and devices should be disposed of in accordance with your local waste regulations.

If you have any questions, please contact PCE Instruments.



PCE Instruments contact information

Germany

PCE Deutschland GmbH
Im Langel 4
D-59872 Meschede
Deutschland
Tel.: +49 (0) 2903 976 99 0
Fax: +49 (0) 2903 976 99 29
info@pce-instruments.com
www.pce-instruments.com/deutsch

Germany

PCE Produktions- und
Entwicklungsgesellschaft mbH
Im Langel 26
D-59872 Meschede
Deutschland
Tel.: +49 (0) 2903 976 99 471
Fax: +49 (0) 2903 976 99 9971
info@pce-instruments.com
www.pce-instruments.com/deutsch

The Netherlands

PCE Brookhuis B.V.
Institutenweg 15
7521 PH Enschede
Nederland
Telefoon: +31 (0)53 737 01 92
info@pcebenelux.nl
www.pce-instruments.com/dutch

United States of America

PCE Americas Inc.
711 Commerce Way suite 8
Jupiter / Palm Beach
33458 FL
USA
Tel: +1 (561) 320-9162
Fax: +1 (561) 320-9176
info@pce-americas.com
www.pce-instruments.com/us

France

PCE Instruments France EURL
23, rue de Strasbourg
67250 Soultz-Sous-Forets
France
Téléphone: +33 (0) 972 3537 17
Numéro de fax: +33 (0) 972 3537 18
info@pce-france.fr
www.pce-instruments.com/french

United Kingdom

PCE Instruments UK Ltd
Unit 11 Southpoint Business Park
Ensign Way, Southampton
Hampshire
United Kingdom, SO31 4RF
Tel: +44 (0) 2380 98703 0
Fax: +44 (0) 2380 98703 9
info@pce-instruments.co.uk
www.pce-instruments.com/english

China

PCE (Beijing) Technology Co., Limited
1519 Room, 6 Building
Zhong Ang Times Plaza
No. 9 Mentougou Road, Tou Gou District
102300 Beijing, China
Tel: +86 (10) 8893 9660
info@pce-instruments.cn
www.pce-instruments.cn

Turkey

PCE Teknik Cihazları Ltd.Şti.
Halkalı Merkez Mah.
Pehlivan Sok. No.6/C
34303 Küçükçekmece - İstanbul
Türkiye
Tel: 0212 471 11 47
Faks: 0212 705 53 93
info@pce- cihazlari.com.tr
www.pce-instruments.com/turkish

Spain

PCE Ibérica S.L.
Calle Mayor, 53
02500 Tobarra (Albacete)
España
Tel. : +34 967 543 548
Fax: +34 967 543 542
info@pce-iberica.es
www.pce-instruments.com/espanol

Italy

PCE Italia s.r.l.
Via Pesciatina 878 / B-Interno 6
55010 Loc. Gragnano
Capannori (Lucca)
Italia
Telefono: +39 0583 975 114
Fax: +39 0583 974 824
info@pce-italia.it
www.pce-instruments.com/italiano

Hong Kong

PCE Instruments HK Ltd.
Unit J, 21/F., COS Centre
56 Tsun Yip Street
Kwun Tong
Kowloon, Hong Kong
Tel: +852-301-84912
jyi@pce-instruments.com
www.pce-instruments.cn